



ACVATIX™

Electromotoric actuators for **SAY..P..** **VPI46**

with a 15 mm stroke

-
- **SAY31P03** Operating voltage AC 230 V, 3-position control signal
 - **SAY61P03** Operating voltage AC/DC 24 V, control signal DC 0...10 V, 4...20 mA
 - **SAY81P03** Operating voltage AC/DC 24 V, 3-position control signal
 - **SAY61P03** Position feedback, override control, choice of flow characteristic
 - For direct mounting on valves; no adjustments required
 - Manual adjuster, position indicator and status indication per LED
 - Optional functions with auxiliary switches, function module

Use

Electromotoric actuators for the operation of Siemens combi valves of type VPI46.40F9.5Q and VPI46.50F12Q with 15 mm stroke as control valves in ventilation, air conditioning, and district heating systems.

Type summary

Product no.	Stock no.	Stroke	Pos. force	Operating voltage	Positioning signal	Spr. ret. time	Pos. time	LED	Manual adjuster	Extra functions
SAY31P03	S55150-A132	15 mm	200 N	AC 230 V	3-position	-	30 s	-	Push and fix	1)
SAY61P03	S55150-A133			AC/DC 24 V	DC 0...10 V DC 4...20 mA 0...1000 Ω			✓		2), 3)
SAY81P03	S55150-A134			3-position	-			1)		

1) Optional accessories: Auxiliary switch ASC10.51

2) Positioning feedback, forced control, characteristic curve changeover

3) Optional accessories: Auxiliary switch ASC10.51, sequence control, control action changeover AZX61.1

Electrical accessories

Product no.	Auxiliary switch ASC10.51
Stock no.	S55845-Z103
SAX31P..	Max. 2
SAX61P..	
SAX81P..	

Mechanical Accessory Weather shield ASK39.1

Ordering



Example

Product no.	Stock no.	Description	Quantity
SAY81P03	S55150-A134	Actuator	1
ASC10.51	S55845-Z103	Auxiliary switch	1

Delivery

Actuators, valves and accessories are supplied in individual packs.

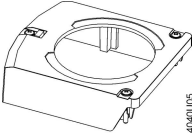
Spare parts

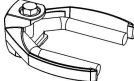
Product number / Stock number	Housing cover	Screw (valve stem coupling)
	8000060843	 
		U-bracket
		

Combinations

Type	Stock no.	DN	H ₁₀₀ [mm]	\dot{V}_{\min} [l/h]	\dot{V}_{100} [l/h]	Δp_{\min} [kPa]	Data sheet
VPI46.40F9.5Q	S55264-V129	40	15	1370	9500	25	N4855
VPI46.50F12Q	S55264-V130	50		1400	11500	36	

Product documentation

Detailed Informations about the New Generation actuators can be found in the Basic documentation for actuators (P4040).

Notes

Engineering

SAY31P03 and
SAY81P03

3-position actuators must have their own specific controller, refer to "Connection Diagrams" (page 8).

SAY61P03

Up to 10 actuators can drive in parallel on a controller output with a rating of 1 mA. Modulating actuators have an input impedance of 100 k Ω .

Mounting

Mounting positions

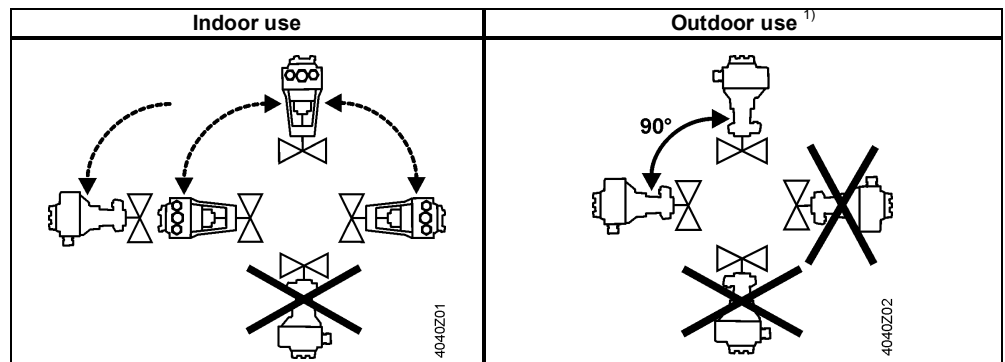

¹⁾ Only in connection with weather shield ASK39.1

Acting direction

With valves whose stem is retracted in the fully closed position, "direct acting" means that the valve is fully closed (100 %) when positioning signal Y = 0 V and Z = 0 Ω respectively.

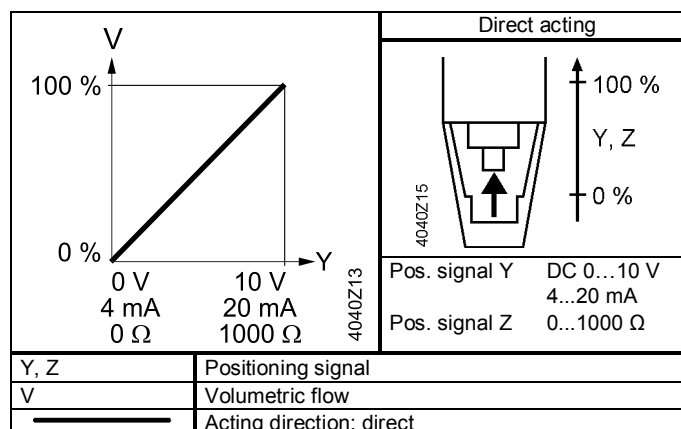

Maintenance

The actuators are maintenance-free.

Warranty

The engineering data specified in chapter "Combinations" (page 3) are only guaranteed in connection with the Siemens valves listed.

Note

When using the actuators in connection with valves of other manufacture, correct functioning must be ensured by the user, and Siemens will assume no responsibility.

Technical Data

		SAY..P
Power supply	Operating voltage SAY31P03 SAY61P03 SAY81P03	AC 230 V ±15% AC 24 V ± 20% / DC 24 V + 20% / -15%(SELV) AC 24 V ±20% / DC 24 V + 20 % / -15%(SELV)
	Frequency	45...65Hz
	External supply line protection (EU)	<ul style="list-style-type: none"> Fuse slow 6...10 A Circuit breaker max. 13 A, Characteristic B, C, D according to EN 60898 Power source with current limitation of max. 10 A
	Power consumption at 50 Hz SAY31P03 Stem retracts / extends SAY61P03 Stem retracts / extends SAY81P03 Stem retracts / extends	6 VA / 3.5 W 8 VA / 3.75 W 5 VA / 3.75 W
Function data	Positioning times (with the specified nominal stroke) The positioning time can vary, depending on the type of valve -> refer chapter "Type summary" (page 2) SAY31P03, SAY61P03, SAY81P03 Positioning force Nominal stroke Permissible medium temperature (valve fitted)	30 s 200 N 15 mm 1...120 °C
Signal inputs	Positioning signal "Y" SAY31P03, SAY81P03 SAY31P.. Voltage SAY81P.. Voltage SAY61P03 (DC 0...10 V) Current draw Input impedance SAY61P03 (DC 4...20 mA) Current draw Input impedance	3-position AC 230 V ±15% AC 24 V ± 20 % / DC 24 V + 20 % / -15% ≤ 0.1 mA ≥ 100 kΩ DC 4...20 mA ± 1% ≤ 500 Ω
Parallel operation	SAY61P03	≤ 10 (depending on controller output)
Forced control	Positioning signal "Z" SAY61P03 R = 0...1000 Ω Z connected to G Z connected to G0 Voltage Current draw	R = 0...1000 Ω, G, G0 Stroke proportional to R Max. stroke 100% ¹⁾ Min. stroke 0% ¹⁾ Max. AC 24 V ± 20% Max. DC 24 V + 20% / -15% ≤ 0.1 mA
Position feedback	Position feedback U SAY61P03 Load impedance Load	DC 0...10 V ± 1% > 10 kΩ res. Max. 1 mA
Connecting cable	Wire cross-sectional areas	0.75...1.5 mm ² , AWG 20...16 ²⁾
	Cable entries SAY..P..	EU: 2 entries Ø 20.5 mm (for M20) 1 entry Ø 25.5 mm (for M25)
Degree of protection	Protection degree of housing from vertical to horizontal	IP54 as per EN 60529 ³⁾
	Protection class Actuators SAY31P03Y AC 230 V Actuators SAY61P03Y AC / DC 24 V Actuators SAY81P03Y AC / DC 24 V	As per EN 60730-1 II III III
Environmental conditions	Operation Climatic conditions Mounting location Temperature General Humidity (noncondensing)	IEC 60721-3-3 Class 3K5 Indoors (weather-protected) 5...55 °C 5...95% r.h.
	Transport Climatic conditions Temperature Humidity	IEC 60721-3-2 Class 2K3 -25...70 °C <95% r.h.
	Storage Climatic conditions Temperature Humidity	IEC 60721-3-1 Class 1K3 -15...55 °C 5...95% r.h.
	Max. media temperatur when mounted on valve	120 °C

¹⁾ Observe acting direction of DIL switches

²⁾ AWG = American wire gauge

³⁾ Also with weather shield ASK39.1

Directives and Standards	Product standard Electromagnetic compatibility (Application)	EN 60730-x For residential, commercial and industrial environments A5W00000333 ¹⁾ A5W00000334 ¹⁾
	EU Conformity (CE) RCM Conformity	AC 230 V -
Environmental compatibility	UL, cUL	AC 230 V AC / DC 24 V UL 873 http://ul.com/database
Dimensions		See "Dimensions" (page 9)
Accessories ²⁾	Auxiliary switch ASC10.51 External supply line protection US installation, UL & cUL	Switching capacity AC 24...230 V, 6 (2) A, floating See section power supply AC 24 V class 2, 5 A general purpose

¹⁾ The documents can be downloaded from <http://siemens.com/bt/download>.

²⁾ UL recognized component 

Connection Diagrams

Internal Diagrams

SAY31P03

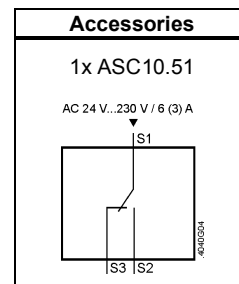
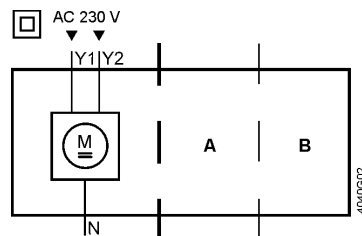

SAY61P03

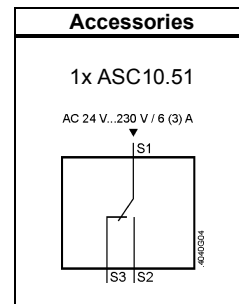
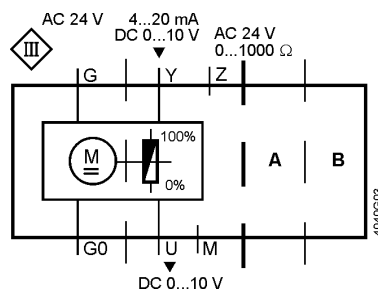

SAY81P03

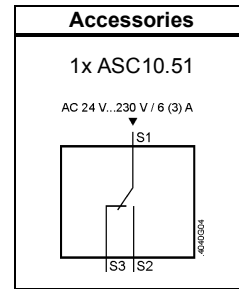
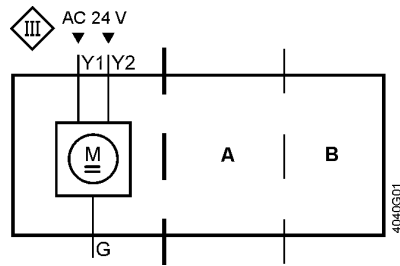

Connection terminals

SAY31P03

AC 230 V, 3-position

- N** - System neutral (SN)
- Y1** - Positioning signal (actuator's stem retracts)
- Y2** - Positioning signal (actuator's stem extends)

SAY61P03

AC/DC 24 V, DC 0...10 V / 4...20 mA / 0...1000 Ω

- G0** - System neutral (SN)
- G** - System potential (SP)
- Y** - Positioning signal for DC 0...10 V / 4...20 mA
- M** - Measuring neutral
- U** - Position feedback DC 0...10 V
- Z** - Positioning signal forced control

SAY81P03

AC/DC 24 V, 3-position

- G** - System potential (SP)
- Y1** - Positioning signal (actuator's stem retracts)
- Y2** - Positioning signal (actuator's stem extends)

Connection Diagrams
SAY31P03

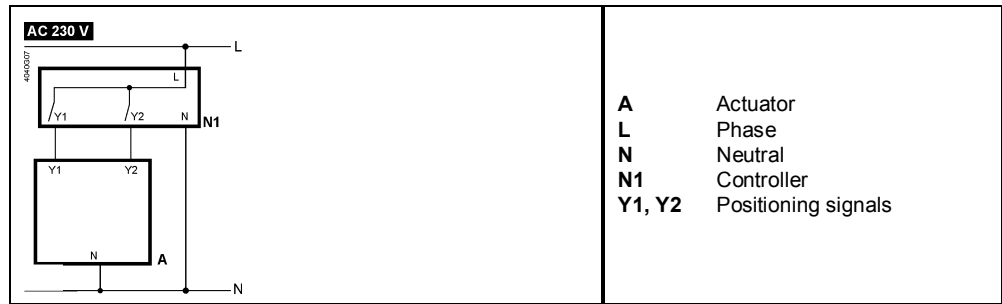

SAY61P03

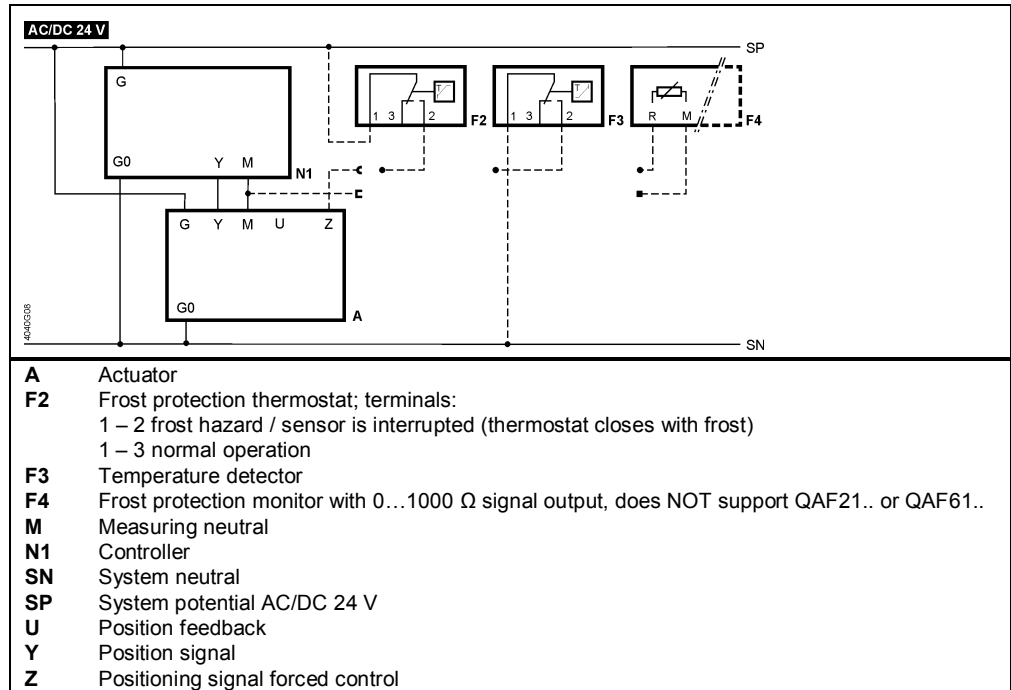

SAY81P03

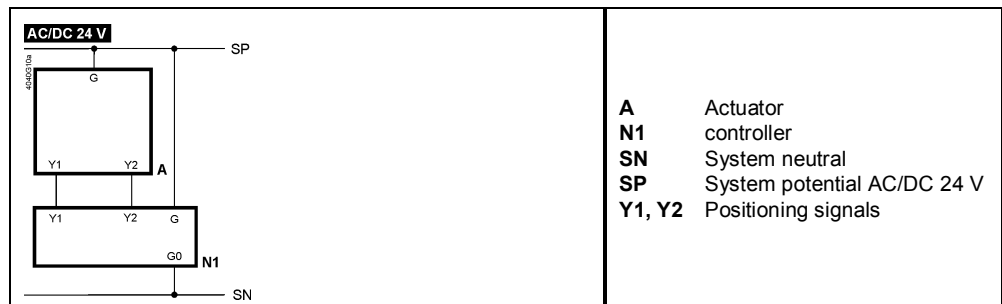

Dimensions

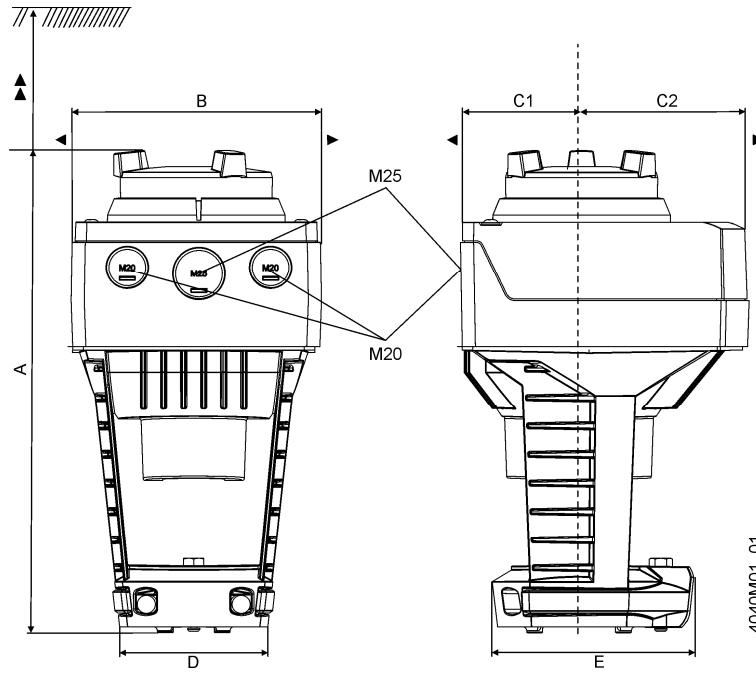

Type	A	B	C	C1	C2	D	E	▶	▶▶	kg
SAY..P..	242	124	150	68	82	80	100	100	200	1,850
With ASK39.1	+25	154	300	200	100	-	-	-	-	2,080

Dimensions in mm

Revision numbers

Product no.	Valid from rev. no.
SAY31P03	..a
SAY61P03	..a
SAY81P03	..a